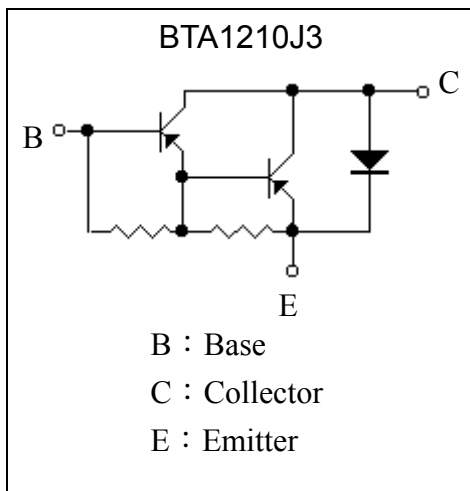
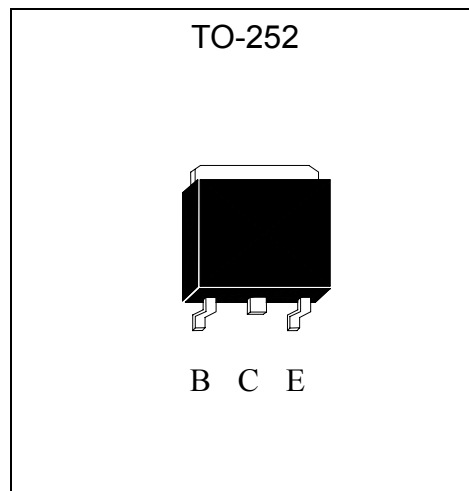

PNP Epitaxial Planar Transistor**BTA1210J3****Description**

The BTA1210J3 is a PNP Darlington transistor, designed for use in general purpose amplifier and low speed switching application.

Features

- High BV_{CEO}
- High DC current gain
- High current capability
- Monolithic construction with built-in base-emitter shunt resistors

Equivalent Circuit**Outline**



Absolute Maximum Ratings (Ta=25°C)

Parameter	Symbol	Limits	Unit
Collector-Base Voltage	V _{CB0}	-120	V
Collector-Emitter Voltage	V _{CE0}	-120	V
Emitter-Base Voltage	V _{EBO}	-5	V
Collector Current (DC)	I _C	-10	A
Collector Current (Pulse)	I _{CP}	-15 (Note)	A
Power Dissipation	Pd(T _A =25°C)	1.75	W
	Pd(T _C =25°C)	20	W
Thermal Resistance, Junction to Ambient	R _{θJA}	83.3	°C/W
Thermal Resistance, Junction to Case	R _{θJC}	6.25	°C/W
Junction Temperature	T _j	150	°C
Storage Temperature	T _{stg}	-55~+150	°C

Note : Single Pulse Pw ≤ 350μs, Duty ≤ 2%.

Characteristics (Ta=25°C)

Symbol	Min.	Typ.	Max.	Unit	Test Conditions
BV _{CE0}	-120	-	-	V	I _C =-1mA, I _B =0
BV _{CB0}	-120	-	-	V	I _C =-100μA, I _E =0
BV _{EBO}	-5	-	-	V	I _E =-1mA, I _C =0
I _{CB0}	-	-	-200	μA	V _{CB} =-120V, I _E =0
I _{CE0}	-	-	-200	μA	V _{CE} =-120V, I _B =0
I _{EBO}	-	-	-2	mA	V _{EB} =-5V, I _C =0
*V _{CE(sat) 1}	-	-	-2	V	I _C =-4A, I _B =-16mA
*V _{CE(sat) 2}	-	-	-4	V	I _C =-8A, I _B =-80mA
*V _{BE(sat)}	-	-	-4.5	V	I _C =-8A, I _B =-80mA
*V _{BE(on)}			-2.8	V	V _{CE} =-4V, I _C =-4A
*h _{FE1}	1	-	12	K	V _{CE} =-4V, I _C =-4A
*h _{FE2}	100	-	-	-	V _{CE} =-4V, I _C =-8A
Cob	-		300	pF	V _{CB} =-10V, I _E =0A, f=1MHz

*Pulse Test : Pulse Width ≤ 380μs, Duty Cycle ≤ 2%



Characteristic Curves

Current Gain vs Collector Current

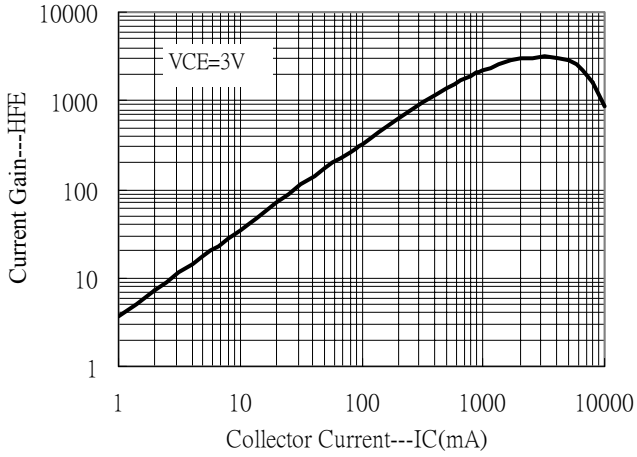

Saturation Voltage vs Collector Current

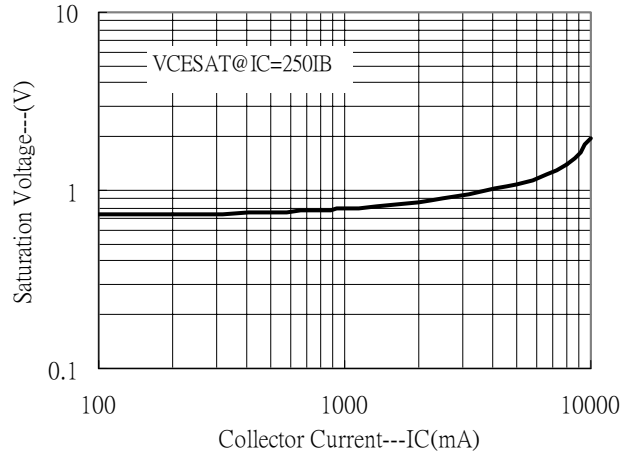

On voltage vs Collector Current

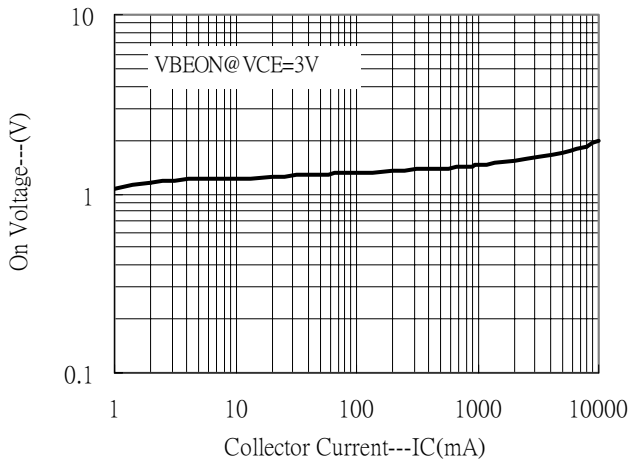

Power Derating Curve

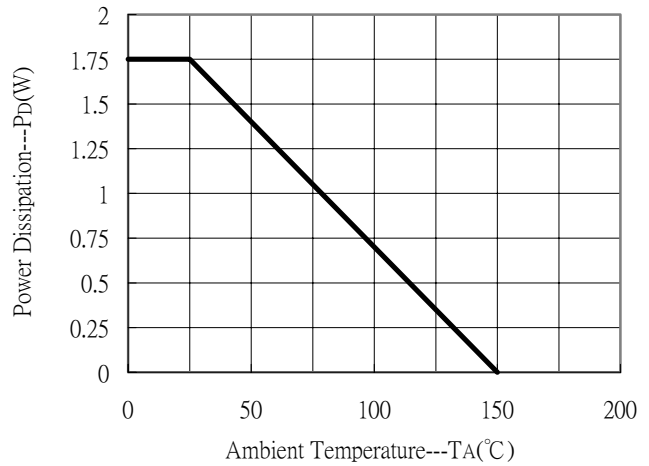

Power Derating Curve

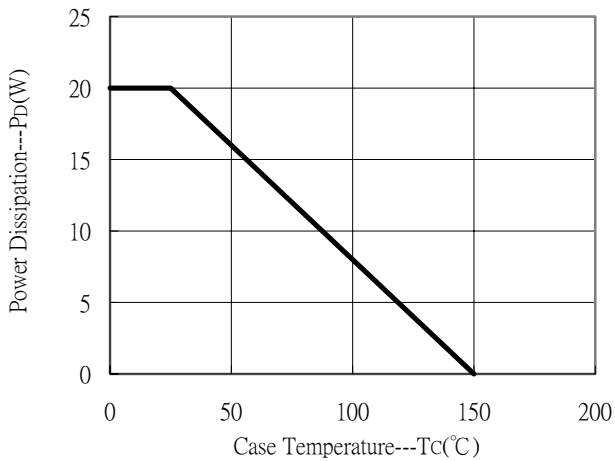

TO-252 Dimension

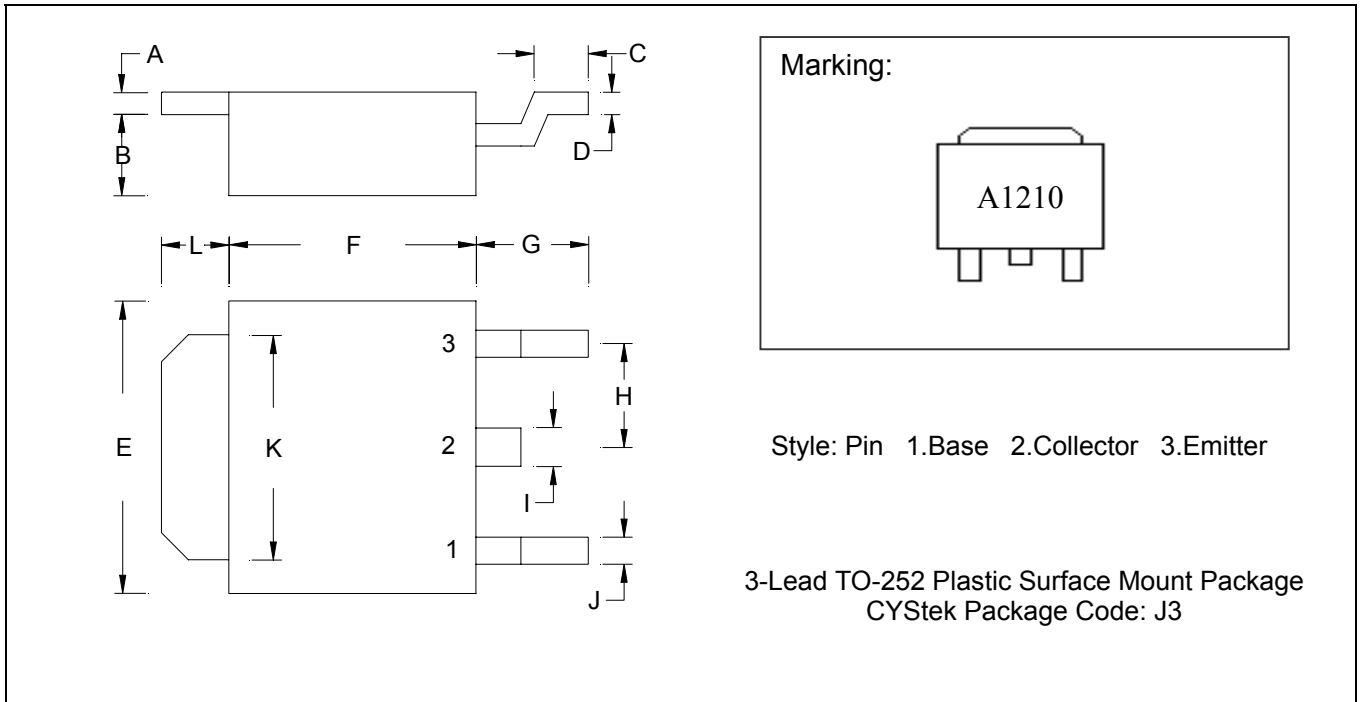

*: Typical

DIM	Inches		Millimeters		DIM	Inches		Millimeters	
	Min.	Max.	Min.	Max.		Min.	Max.	Min.	Max.
A	0.0177	0.0217	0.45	0.55	G	0.0866	0.1102	2.20	2.80
B	0.0650	0.0768	1.65	1.95	H	-	*0.0906	-	*2.30
C	0.0354	0.0591	0.90	1.50	I	-	0.0354	-	0.90
D	0.0177	0.0236	0.45	0.60	J	-	0.0315	-	0.80
E	0.2520	0.2677	6.40	6.80	K	0.2047	0.2165	5.20	5.50
F	0.2125	0.2283	5.40	5.80	L	0.0551	0.0630	1.40	1.60

Notes: 1.Controlling dimension: millimeters.
 2.Maximum lead thickness includes lead finish thickness, and minimum lead thickness is the minimum thickness of base material.
 3.If there is any question with packing specification or packing method, please contact your local CYStek sales office.

Material:

- Lead: 42 Alloy; solder plating
- Mold Compound: Epoxy resin family, flammability solid burning class: UL94V-0

Important Notice:

- All rights are reserved. Reproduction in whole or in part is prohibited without the prior written approval of CYStek.
- CYStek reserves the right to make changes to its products without notice.
- CYStek **semiconductor products are not warranted to be suitable for use in Life-Support Applications, or systems.**
- CYStek assumes no liability for any consequence of customer product design, infringement of patents, or application assistance.